

Montageanweisung / Installation instructions / Instruction de montage / Istruzioni di montaggio
montagehandleiding / Instrukja montażu / Montaj talimatlar / Összeszerelési útmutató / Nàvod k montáži /
Nàvod na montaž / Instrucțiune de montaj / Инструкция по монтажу / Montaj talimatina / Monteringsanvisningar
Upute za montažu / Instrucciones de Montaje / Navodila za montažo

INFINITY

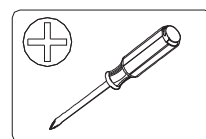

30 Min.

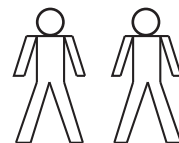

D Bitte lesen Sie diese Montageanleitung gut durch, da wir für Fehler, die durch falsche Montage entstehen, keine Haftung übernehmen!

GB Please read these installation instructions through carefully as we cannot accept any liability for faults occurring as a result of incorrect installation!

CZ Přečtěte si prosím pozorně tento návod k montáži, aby jste předešli chybám vzniklých špatnou montáží, za které neručíme!

F Veuillez lire attentivement cette notice de montage, car nous déclinons toute responsabilité en cas d'erreurs découlant d'un montage erroné !

I Prego leggere attentamente le istruzioni per il montaggio, poiché decliniamo qualsiasi responsabilità per difetti derivanti da un montaggio errato

S Läs monteringsanvisningarna noggrant. Vi avsäger oss allt ansvar för defekter som uppstår p.g.a. felaktig montering.

HR Pažljivo pročitajte upute za montažu, jer otklanjamo svaku odgovornost za pogreške nastale uslijed pogrešne montaže.

SLO Prosimo, da pozorno preberete navodila za montažo, saj zavračamo vsakršno odgovornost za napake, ki bi nastale zaradi napačne montaže.

NL Leest u alstublieft deze montagehandleiding goed door, voor fouten door verkeerde montage zijn wij niet verantwoordelijk.

PL Proszę uważnie zapoznać się z instrukcją montażu, ponieważ nie ponosimy odpowiedzialności za niewłaściwy montaż.

HU Kérjük, olvassa el figyelmesen ezt az összeszerelési útmutatót, mert a helytelen összeszerelésből a dódó hibákért nem vállalunk felelősséget!

SK Prosíme, dobre prečítajte si tento návod na montáž, pretože nepreberáme žiadne ručenie za chyby, ktoré vzniknú na základe chybnej montáže!

RO Vă rugăm să citiți cu atenție aceste instrucțiuni de montaj deoarece nu preluăm garanția pentru defecte ce apar datorită unui montaj incorect!

RUS Пожалуйста, внимательно ознакомьтесь с данной инструкцией по монтажу, поскольку мы не несем ответственности за ошибки, причиной которых является неправильный монтаж.



TU İlk önce kullanma klavuzunu iyi okuyun, yanlış montaj yaparsanız bunun sorumlusu biz degiliz.

E Se ruego leer con atención las instrucciones de montaje debido a que declinamos cualquier responsabilidad por defectos derivados de un montaje erróneo

LC S.p.A
Via del Piano s.n
61030 Isola del Piano (PU)
Italia

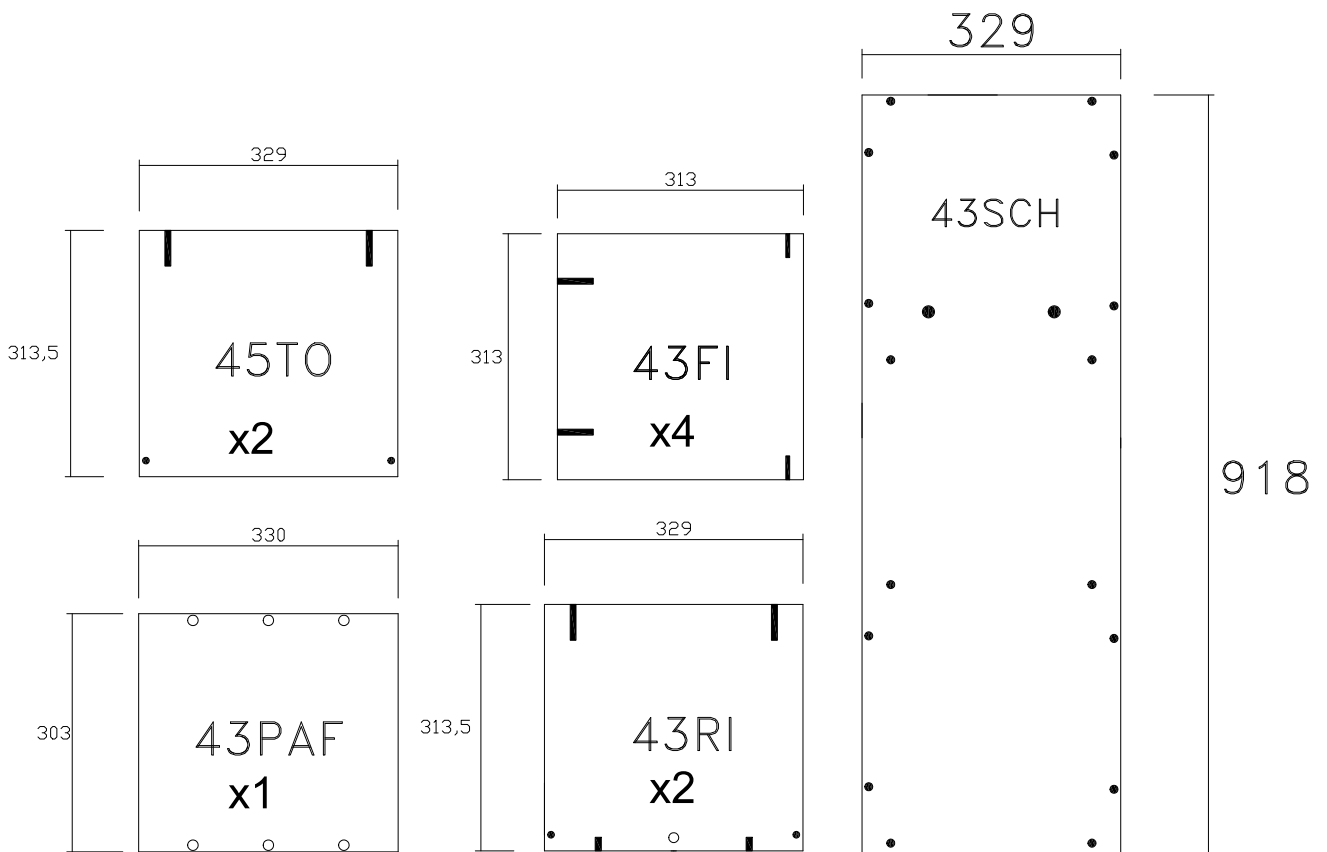
SERVICEKARTE-SPAREPARTS LIST-CARTE SERVICE-SCHEDA DI SERVIZIO
SERVICEKAART-SERVISNI KARTA-HIZMET KARTI- обслуживание карт

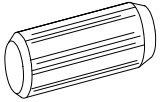
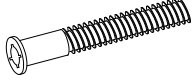
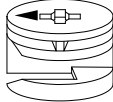
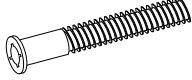
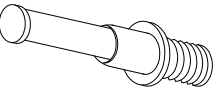
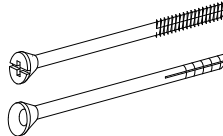

B		V760	
	8x30 mm.	x4	7x60 mm. x16
C		V550	
	ø16 mm.	x2	5x50 mm. x8
D		N8-100	
	x2	T16	
		ø16 mm.	x2

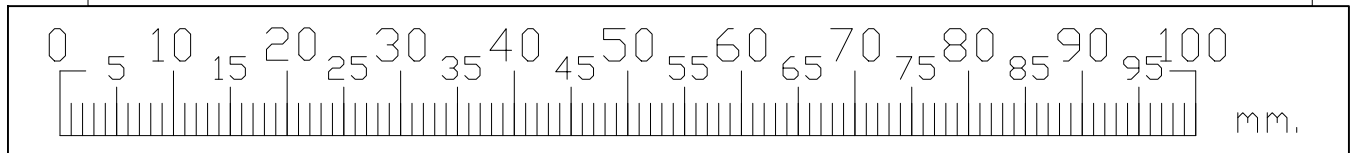

1

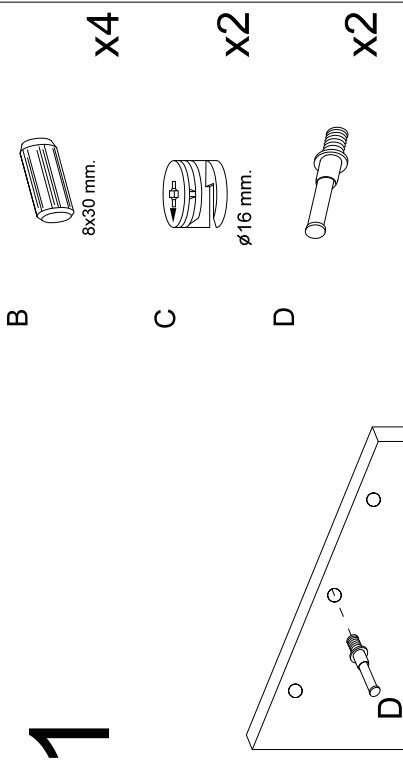

2

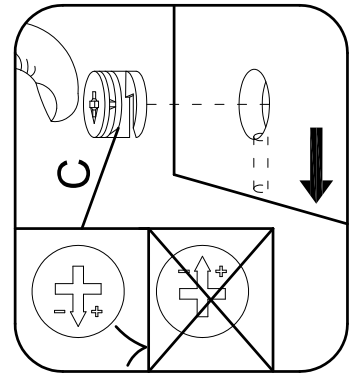
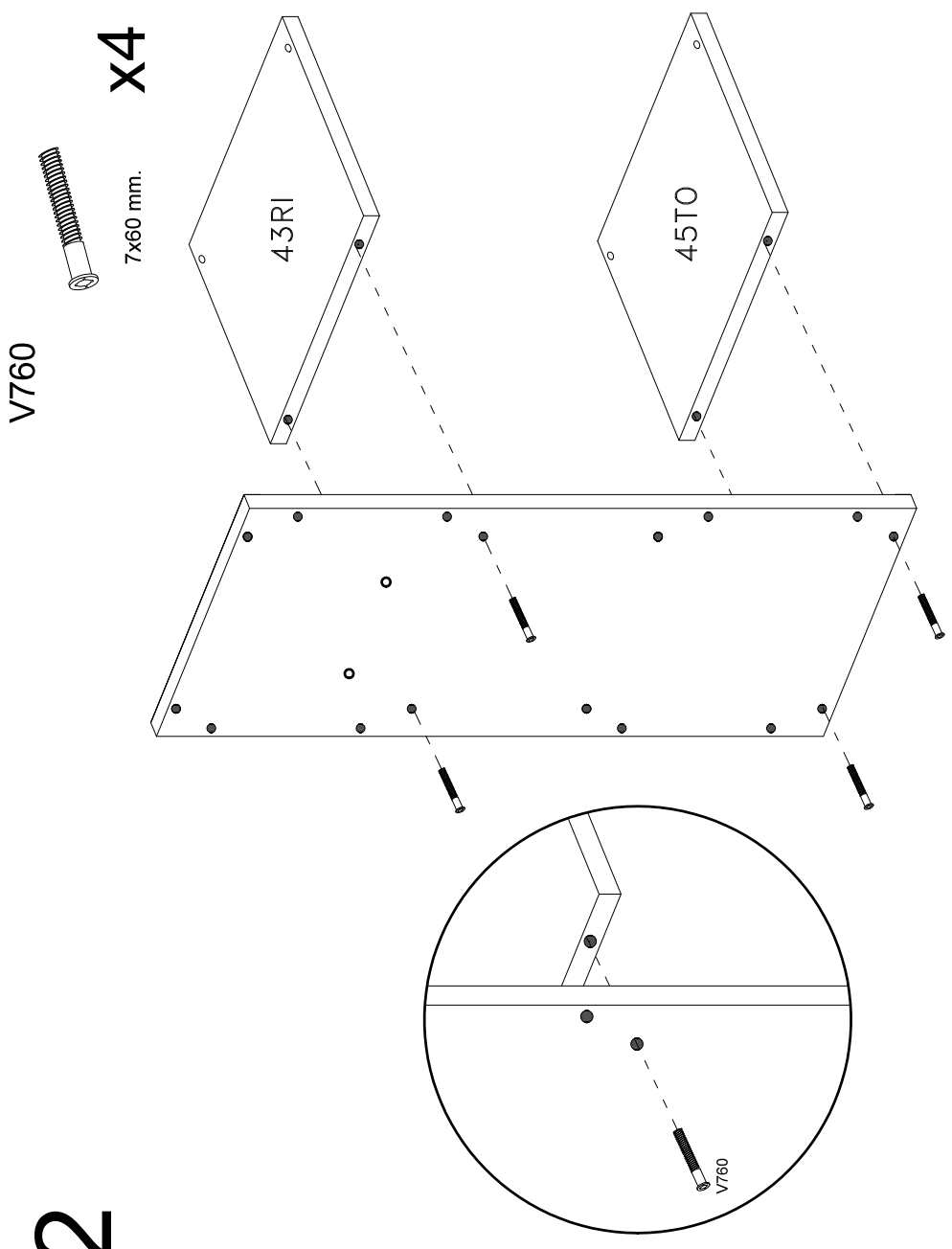

3

V760



7x60 mm.

X8

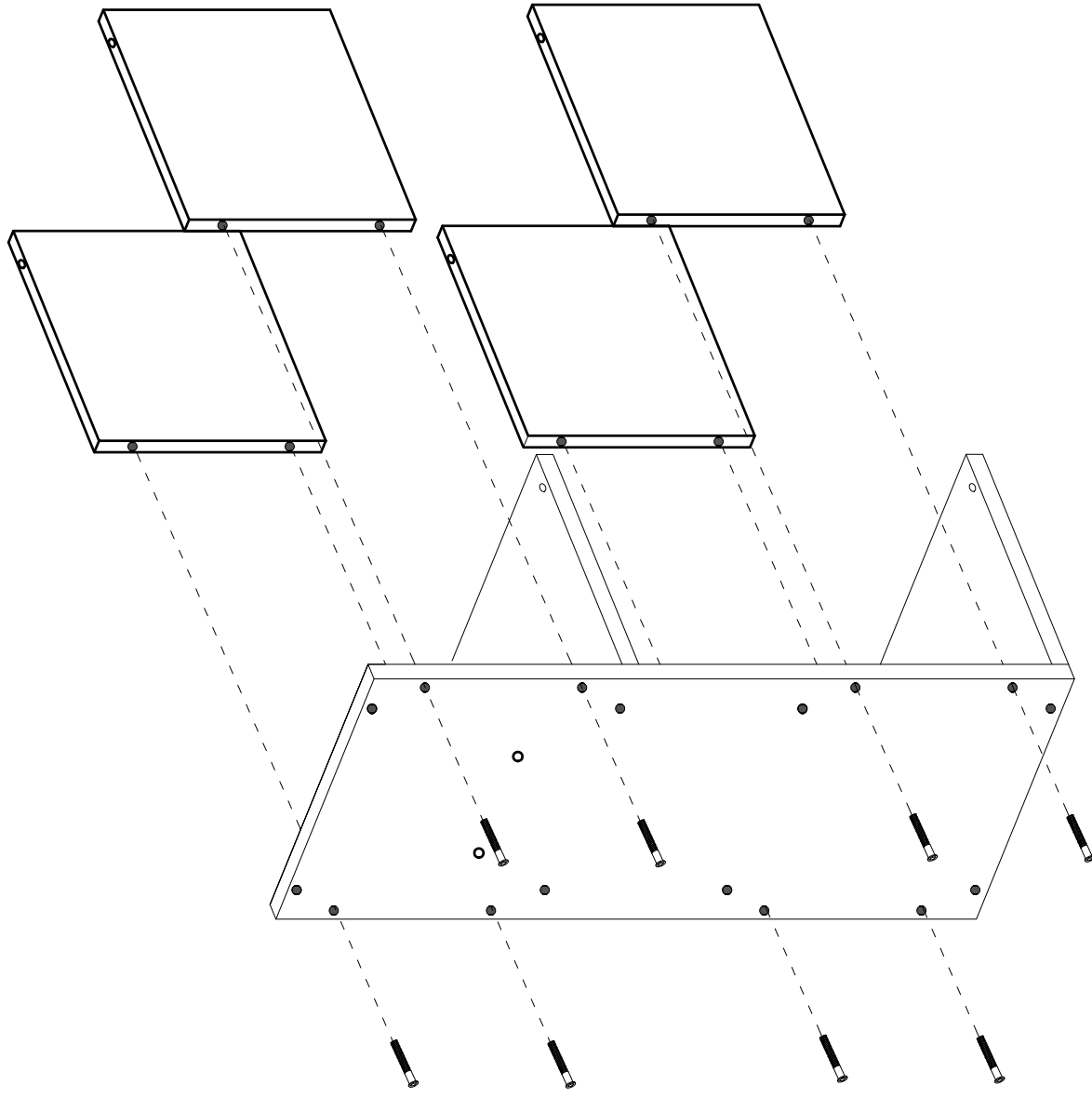
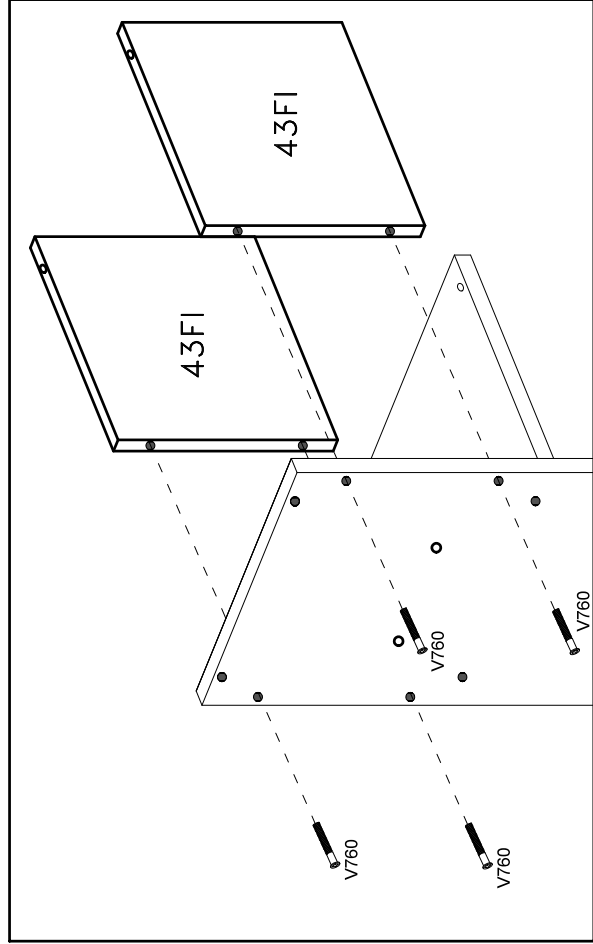

4

V550



X4

5x60 mm.

X4

V760



7x60 mm.

X4

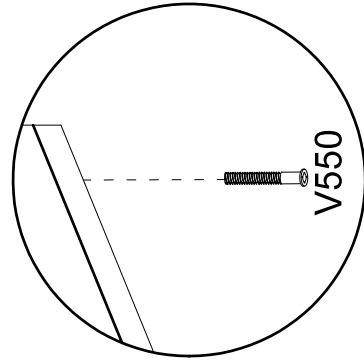
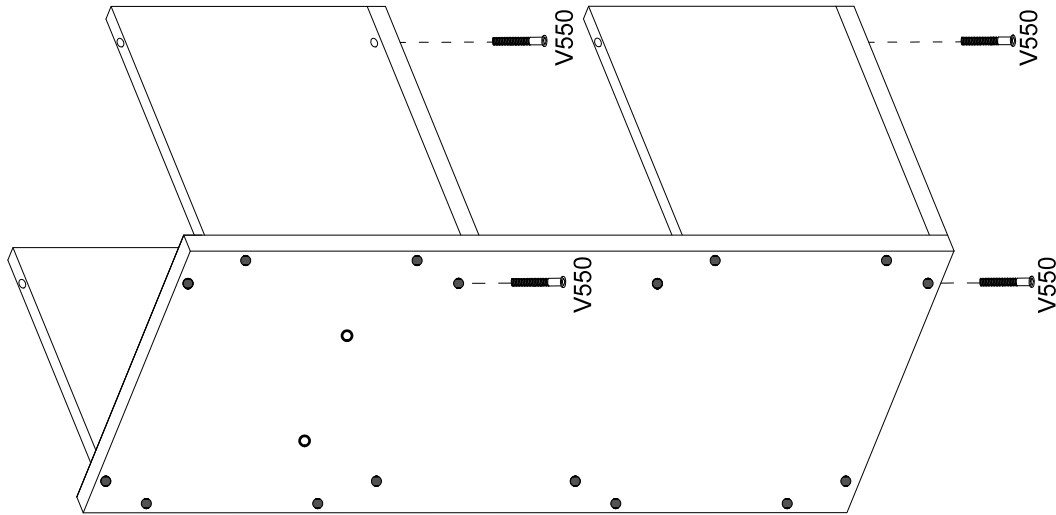

V550

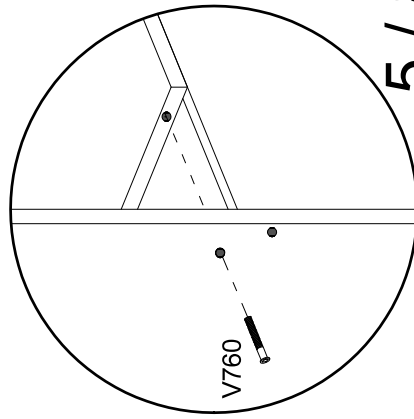
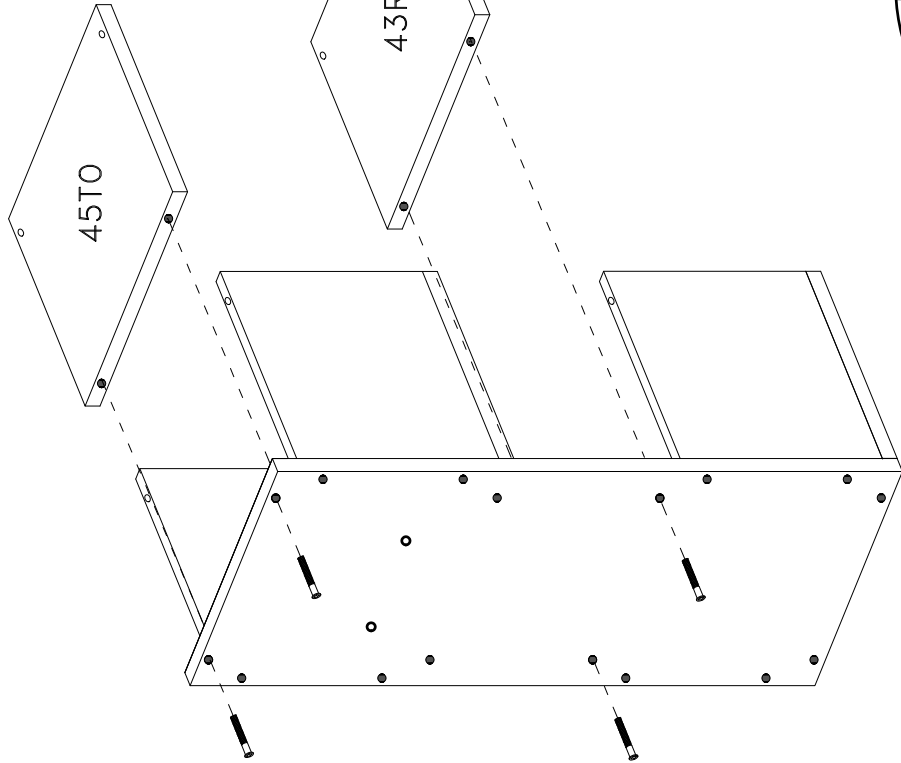

V760

5 / 8

5

V550



5x50 mm.

X4

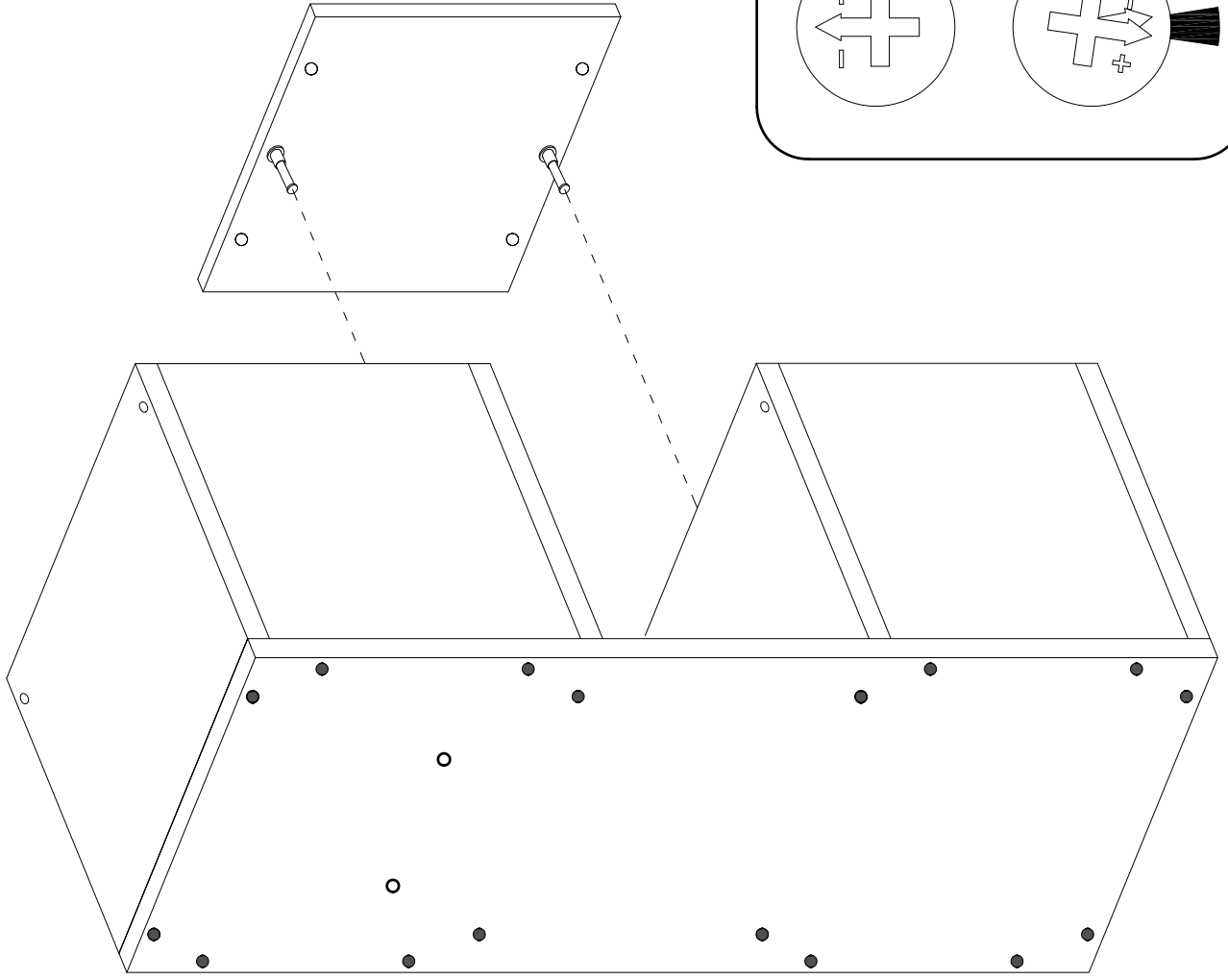
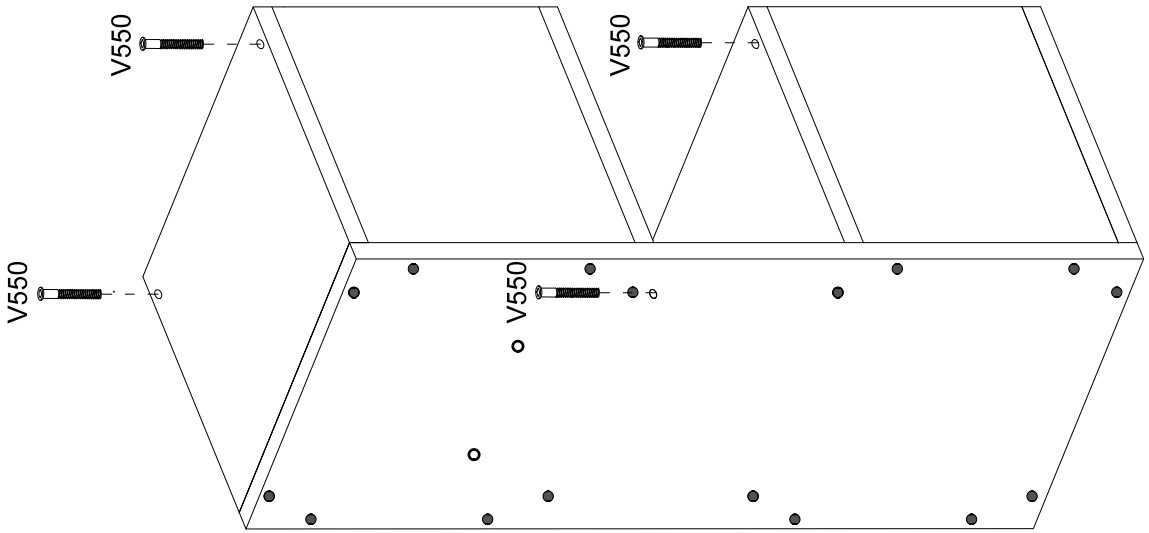

6 / 8

6

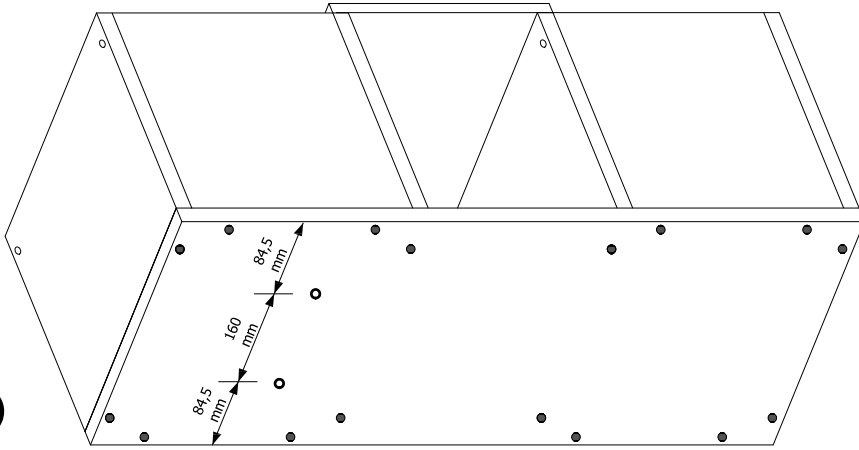

Ø8mm

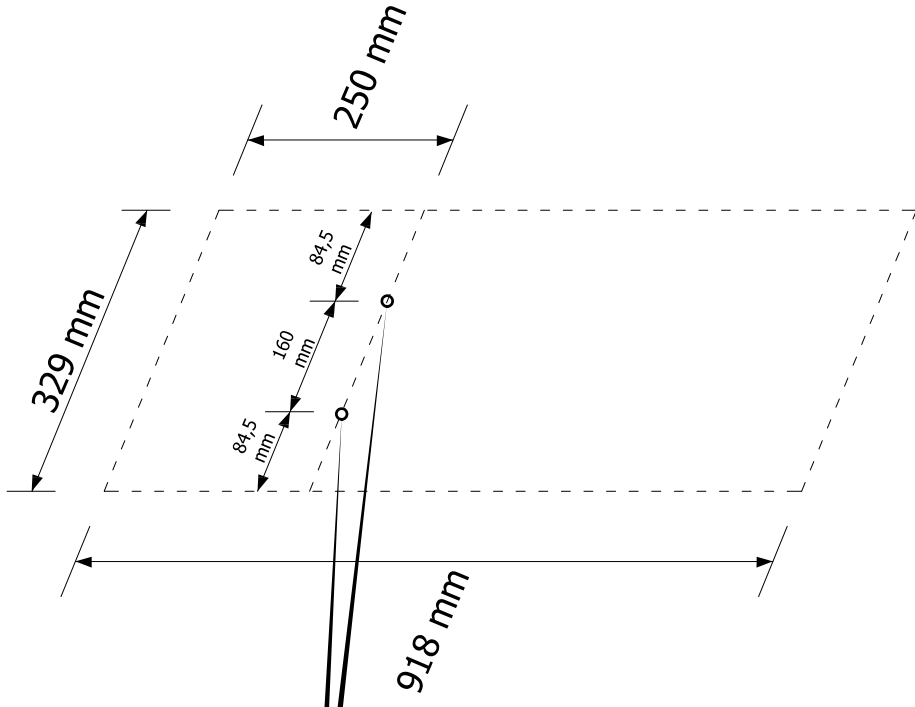
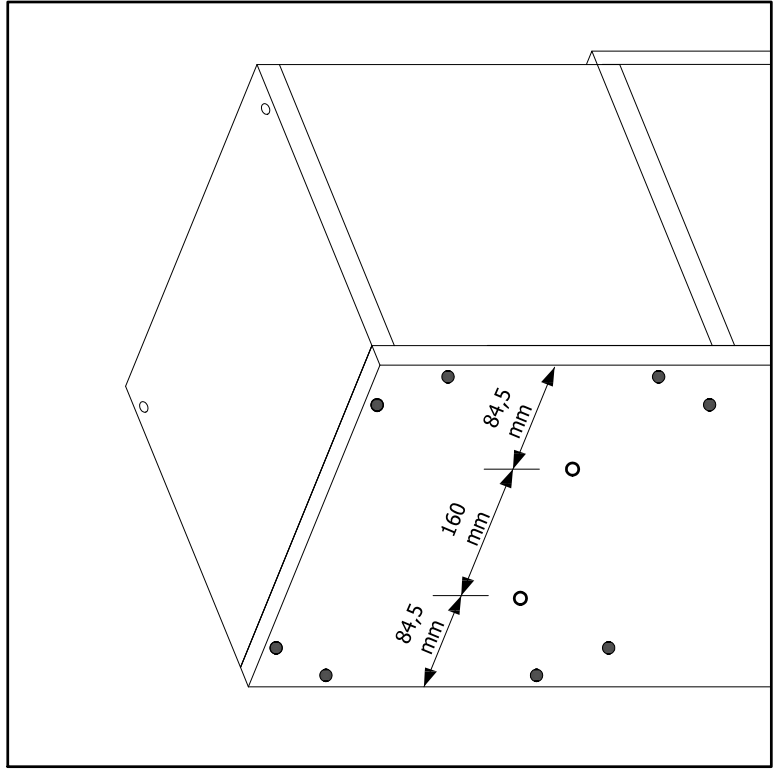
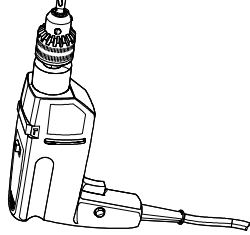

7

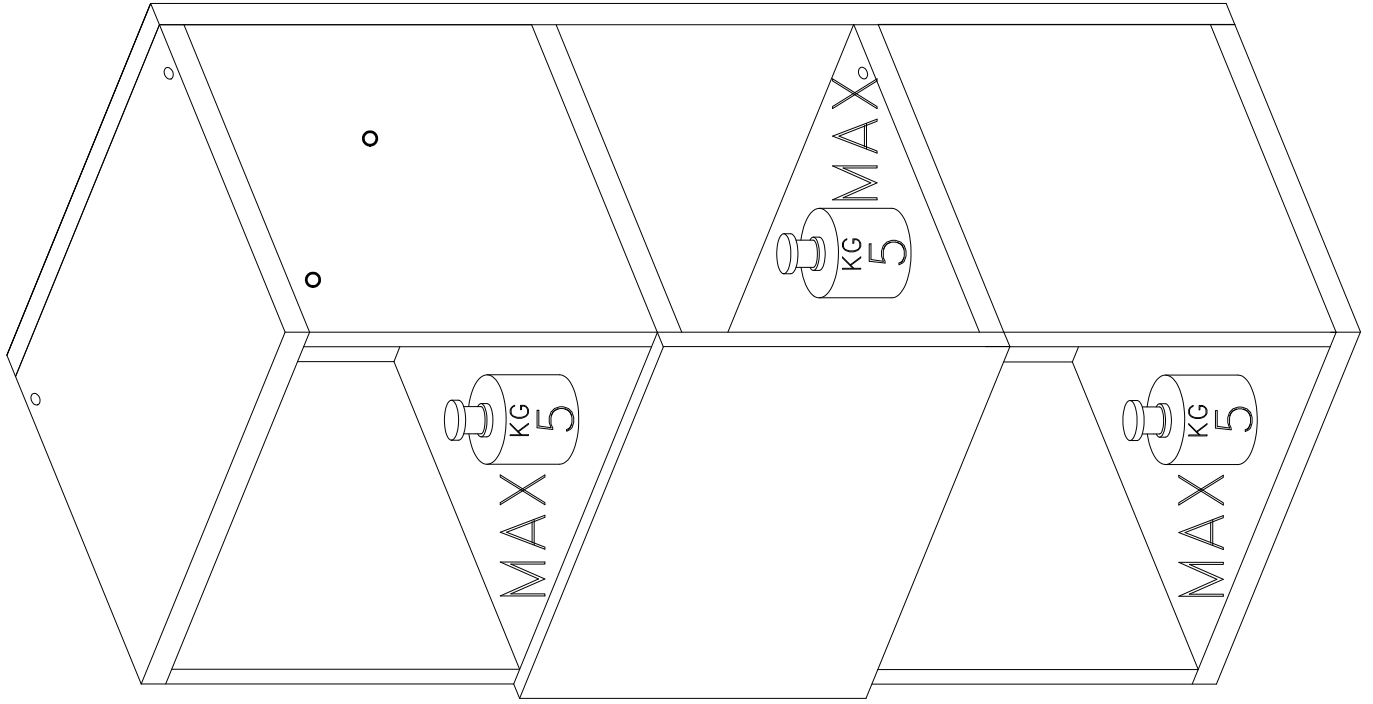

N8-100

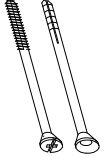

x2

T16



x2

Ø16 mm.

