

Montageanleitung

Modellname: **TOP**

Modellreihe: **A4 SK 00 70**

Seite **1** von **3**

- ① Boden
- ② Paneel

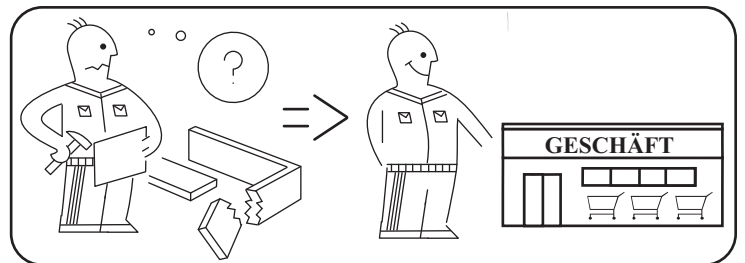
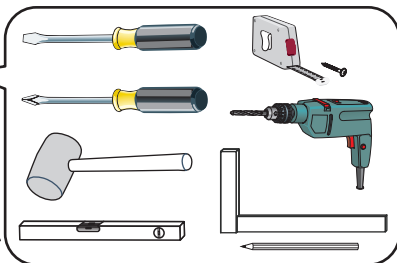
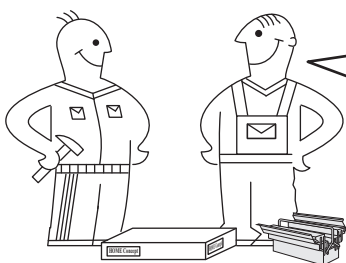
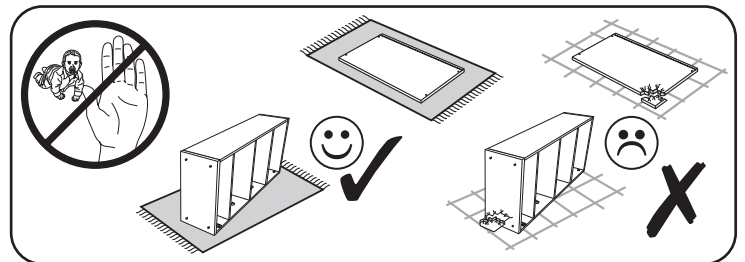
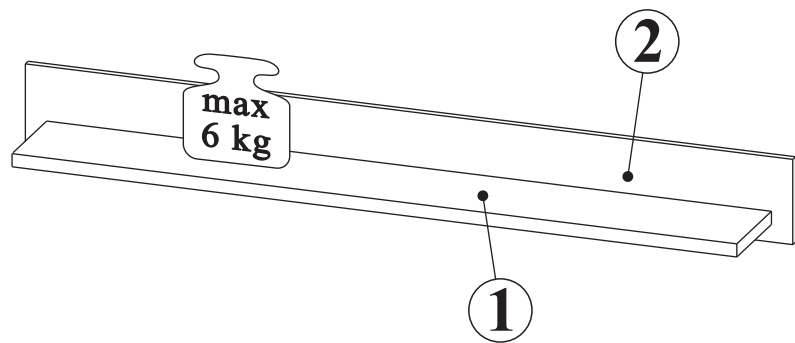



B11

Z10

8704

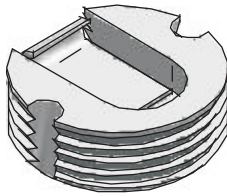

x3

E6

1007



ES 6x9,5

x6

T10

1274
8281

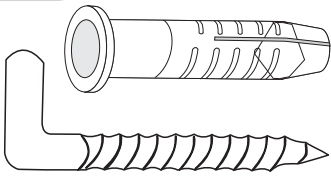

x3

K1

1354

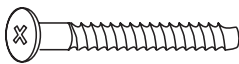

7x50

x5

G35

8847

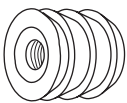

x2

G36

8848

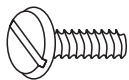

M 4x10

x2

1

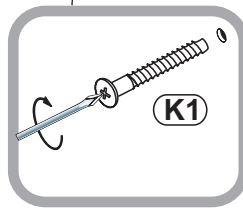
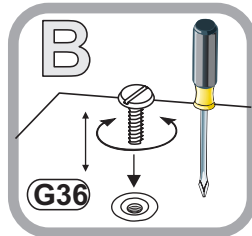
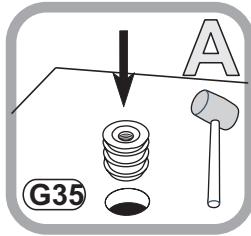
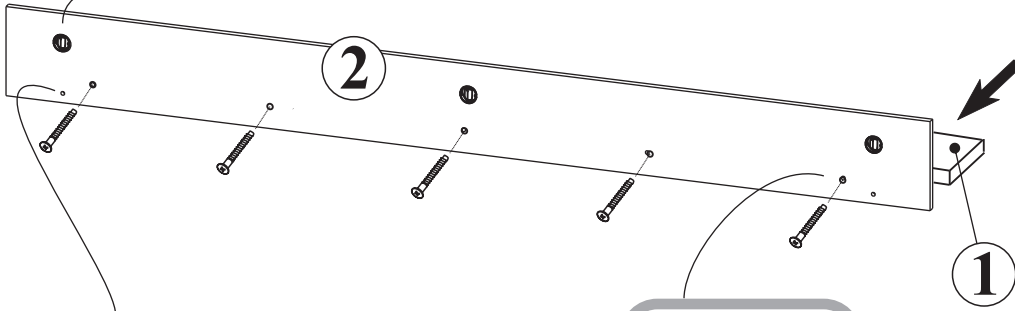
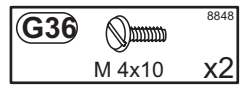
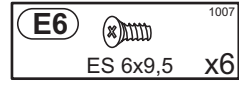
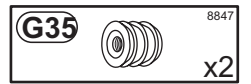
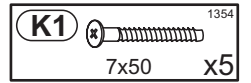
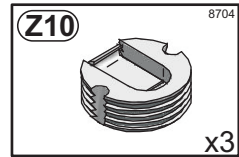
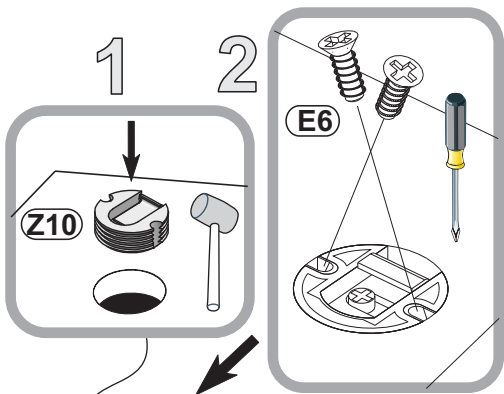

2

